

### General Description

The AAT351x PowerManager products are members of AnalogicTech's Total Power Management IC™ (TPMIC™) product family. This family of microprocessor reset circuits provides the ultimate in versatility, allowing system designers full customization of the  $\mu$ P monitor and reset function without any additional components. The AAT351x family offers several combinations of threshold voltage, watchdog timeout period, reset active period, and output drive configurations, which are all factory-programmed options. All devices are available in 32 reset threshold voltages from 2.6V up to 5V, with three watchdog timeout periods from 6.3ms to 1600ms and three reset timeouts from 1ms up to 140ms. Available output configurations are active low push-pull, active low open drain, active low bi-directional, and active high push-pull.

The AAT351x family is designed to ignore fast negative transients on  $V_{DD}$  and to ensure that reset outputs remain valid down to 1V.

The AAT351x family is available in the Pb-free, space-saving 5-pin SOT23 surface mount package and is specified over the -40 to +85°C temperature range.

### Features

- Tight Voltage Tolerance:  $\pm 1.5\%$
- Low Quiescent Current: 5 $\mu$ A
- Guaranteed Reset Valid Down to 1V
- 32 Voltage Options from 2.6V to 5.0V
- Three Reset Active Period Options:
  - 1ms, 20ms, 140ms
- Three Watchdog Timeout Period Options:
  - 6.3ms, 102ms, 1600ms
- Four Output Options:
  - Open Drain
  - Inverting
  - Non-Inverting
  - Bi-Directional
- Low Temperature Coefficient: 100ppm/°C
- 5-Pin SOT23 Package

### Applications

- Critical  $\mu$ P and  $\mu$ C Supply Monitoring
- Embedded Control Systems
- Industrial Controllers
- Intelligent Instruments
- Notebook Computers
- Portable Electronics
- Power-On Reset Circuits

### Typical Application

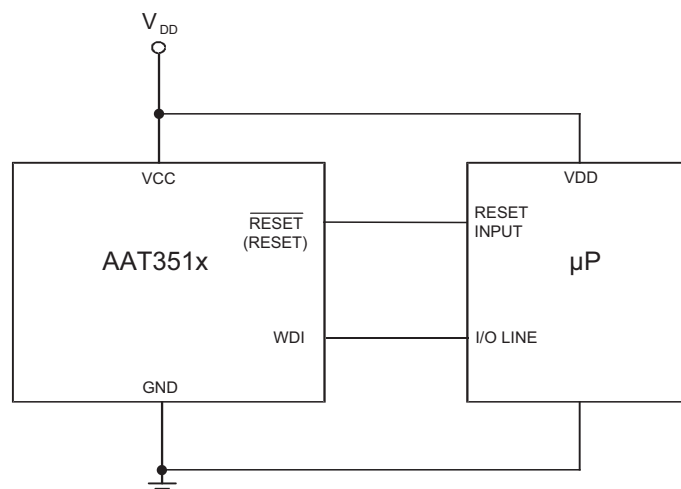

### Pin Descriptions

Pin #				Symbol	Function
AAT3510 AAT3511 AAT3517	AAT3512	AAT3513 AAT3514 AAT3518	AAT3515 AAT3516 AAT3519		
1	N/A	1	1	$\overline{\text{RESET}}$	AAT3510/13/15: $\overline{\text{RESET}}$ output goes low whenever $V_{DD}$ falls below the reset threshold. CMOS push-pull output. AAT3511/14/16: $\overline{\text{RESET}}$ output goes low whenever $V_{DD}$ falls below the reset threshold. Bidirectional CMOS push-pull output intended to interface directly to microprocessors with bi-directional resets. AAT3517/18/19: $\overline{\text{RESET}}$ output goes low whenever $V_{DD}$ falls below the reset threshold. Open drain output. Connect a pull-up resistor to any supply voltage up to 5.5V.
2	2	2	2	GND	Ground connection pin.
N/A	1	3	3	RESET	RESET active-high output. This CMOS push-pull signal is the logical inverse of $\overline{\text{RESET}}$ .
3	3	N/A	4	$\overline{\text{MR}}$	Manual reset input pin. Active low. Pull low to force a reset.
4	4	4	N/A	WDI	Watchdog input pin. Triggers a reset if it remains in a steady state for the duration of the watchdog timer period.
5	5	5	5	VCC	Input voltage pin.

### Pin Configuration

5-lead SOT23  
(Top View)

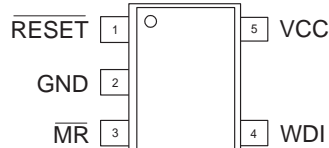

AAT3510  
AAT3511  
AAT3517

5-lead SOT23  
(Top View)

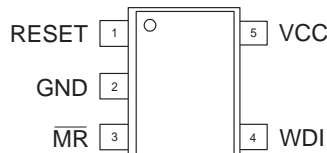

AAT3512

5-lead SOT23  
(Top View)

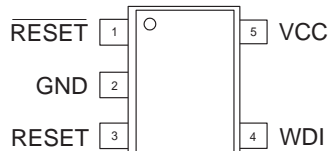

AAT3513  
AAT3514  
AAT3518

5-lead SOT23  
(Top View)

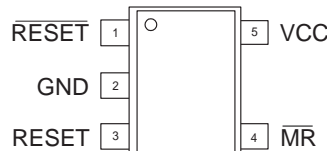

AAT3515  
AAT3516  
AAT3519

### Absolute Maximum Ratings<sup>1</sup>

$T_A = 25^\circ\text{C}$ , unless otherwise noted.

Symbol	Description	Max	Units
$V_{CC}$	$V_{CC}$ to GND	-0.3 to 6	V
$V_{MR}, V_{WDI}$	MR, WDI to GND	-0.3 to $V_{CC} + 0.3$	V
$V_{RESET}$	$\overline{RESET}$ to GND (Push-Pull or Bidirectional Output)	-0.3 to $V_{CC} + 0.3$	V
	RESET to GND (Open Drain Output)	-0.3 to 6	
$I_{VCC}, I_{MR}, I_{WDI}$	Maximum Continuous Input Current	20	mA
$I_{RESET}$	RESET/ $\overline{RESET}$ Output Current	20	mA
$dV_{CC}/dt$	Rate of Rise of $V_{CC}$	100	V/ $\mu$ s
$T_J$	Operating Junction Temperature Range (-40°C to +150°C)	150	°C

### Thermal Information<sup>2</sup>

Symbol	Description	Value	Units
$\theta_{JA}$	Maximum Thermal Resistance	190	°C/W
$P_D$	Maximum Power Dissipation	526	mW

1. Stresses above those listed in Absolute Maximum Ratings may cause permanent damage to the device. Functional operation at conditions other than the operating conditions specified is not implied. Only one Absolute Maximum Rating should be applied at any one time.  
 2. Mounted on an FR4 board.

### Electrical Characteristics

$V_{CC} = 2.5V$  to  $5.5V$ ,  $T_A = -40^\circ C$  to  $+85^\circ C^1$ , unless otherwise noted. Typical values are at  $T_A = 25^\circ C$ .

Symbol	Description	Conditions	Min	Typ	Max	Units
$V_{CC}$	Operating Voltage Range	$T_A = -40^\circ C$ to $+85^\circ C$	1		5.5	V
$I_{CC}$	Supply Current	AAT3510/1/2/3/4/7/8: $\overline{MR}$ & WDI Unconnected	$V_{CC} = 3.6V$	5	15	$\mu A$
			$V_{CC} = 5.5V$	6	18	
		AAT3515/6/9: $\overline{MR}$ Unconnected	$V_{CC} = 3.6V$		15	
			$V_{CC} = 5.5V$		18	
$V_{TH}$	Reset Threshold Voltage	$T_A = 25^\circ C$	$V_{THNOM} - 1.5\%$	$V_{TH}$	$V_{THNOM} + 1.5\%$	V
		$T_A = -40$ to $+85^\circ C$	$V_{THNOM} - 2.5\%$	$V_{TH}$	$V_{THNOM} + 2.5\%$	
$T_C$	Reference Voltage Temperature Coefficient	$-40^\circ C < T_A < +85^\circ C$		$\pm 40$		ppm/ $^\circ C$
$t_{RP}$	Reset Active Timeout Period	AAT351xIGV-xx-A-x-T1	1	1.4	2	ms
		AAT351xIGV-xx-B-x-T1	20	28	40	
		AAT351xIGV-xx-C-x-T1	140	200	280	
$T_{RD}$	$V_{CC}$ to RESET Delay	$V_{CC}$ Falling at $1mV/\mu s$		40		$\mu s$
<b>Push/Pull RESET Output (AAT3510, 3512, 3513, 3514, 3515, 3516, 3518, 3519)</b>						
$V_{OL}$	$\overline{RESET}$ Low Output Voltage	$V_{CC} \geq 1.0V$ , $I_{SINK} = 50\mu A$			0.3	V
		$V_{CC} \geq 1.2V$ , $I_{SINK} = 100\mu A$			0.3	
		$V_{CC} \geq 2.7V$ , $I_{SINK} = 1.2mA$			0.3	
		$V_{CC} \geq 4.5V$ , $I_{SINK} = 3.2mA$			0.4	
$V_{OH}$	$\overline{RESET}$ High Output Voltage	$V_{CC} \geq 2.7V$ , $I_{SOURCE} = 500\mu A$	$0.8 \times V_{CC}$			V
		$V_{CC} \geq 4.5V$ , $I_{SOURCE} = 800\mu A$	$V_{CC} - 1.5$			
$V_{OH}$	RESET Low Output Voltage	$V_{CC} \geq 2.7V$ , $I_{SINK} = 1.2mA$			0.3	V
		$V_{CC} \geq 4.5V$ , $I_{SINK} = 3.2mA$			0.4	
	RESET High Output Voltage	$V_{CC} \geq 1.8V$ , $I_{SOURCE} = 150\mu A$	$0.8 \times V_{CC}$			
		$V_{CC} \geq 2.7V$ , $I_{SOURCE} = 500\mu A$	$0.8 \times V_{CC}$			
		$V_{CC} \geq 4.5V$ , $I_{SOURCE} = 800\mu A$	$V_{CC} - 1.5$			
<b>Bidirectional RESET Output (AAT3511, 3514, 3516)</b>						
$t_S$	Transition Flip-Flop Setup Time <sup>2</sup>			400		ns
$t_R$	$\overline{RESET}$ Output Rise Time <sup>3</sup>	$V_{CC} = 3.0V$ , $C_L = 120pF$			333	ns
		$V_{CC} = 5.0V$ , $C_L = 200pF$			333	
		$V_{CC} = 3.0V$ , $C_L = 250pF$			666	
		$V_{CC} = 5.0V$ , $C_L = 400pF$			666	
$V_{PTH}$	Active Pull-Up Enable Threshold	$V_{CC} = 5.0V$	0.4	0.65		V
	$\overline{RESET}$ Active Pull-Up Current	$V_{CC} = 5.0V$		20		mA
	$\overline{RESET}$ Pull-Up Resistance		4.2	4.7	5.2	$k\Omega$

1. Over-temperature limits are guaranteed by design, not production tested.  
 2. This is the minimum time RESET must be held low by an external pull-down source to set the active pull-up flip-flop.  
 3. Measured from RESET  $V_{OL}$  to  $(0.8 \times V_{CC})$ , open circuit output.

### Electrical Characteristics

$V_{CC} = 2.5V$  to  $5.5V$ ,  $T_A = -40^\circ C$  to  $+85^\circ C^1$ , unless otherwise noted. Typical values are at  $T_A = 25^\circ C$ .

Symbol	Description	Conditions	Min	Typ	Max	Units
<b>Open-Drain <math>\overline{RESET}</math> Output (AAT3517, 3518, 3519)</b>						
$V_{OL}$	$\overline{RESET}$ Low Output Voltage	$V_{CC} \geq 1.0V, I_{SINK} = 50\mu A$			0.3	V
		$V_{CC} \geq 1.2V, I_{SINK} = 100\mu A$			0.3	
		$V_{CC} \geq 2.7V, I_{SINK} = 1.2mA$			0.3	
		$V_{CC} \geq 4.5V, I_{SINK} = 3.2mA$			0.4	
$I_{D(OFF)}$	Reset Leakage Current				1.0	$\mu A$
<b>Watchdog Input (AAT3510, 3511, 3512, 3513, 3514, 3517, 3518)</b>						
$t_{WD}$	Watchdog Timeout Period	AAT351xIGV-xx-x-A-T1	4.3	6.3	9.3	ms
		AAT351xIGV-xx-x-B-T1	71	102	153	
		AAT351xIGV-xx-x-C-T1 <sup>2</sup>	1.12	1.6	2.4	s
$t_{WDI}$	WDI Minimum Pulse Width	$V_{IL} = 0.3 \times V_{CC}, V_{IH} = 0.7 \times V_{CC}$		50		ns
$V_{IL}$	WDI Input Threshold <sup>3</sup>		$0.3 \times V_{CC}$			
$V_{IH}$	WDI Input Threshold <sup>3</sup>				$0.8 \times V_{CC}$	V
$I_{WDI}$	WDI Input Current <sup>4</sup>	WDI = $V_{CC}$ , Time Average		120	160	$\mu A$
		$V_{WDI} = 0$ , Time Average	-20	-15		
<b>Manual <math>\overline{RESET}</math> Input (AAT3510, 3511, 3512, 3515, 3516, 3517, 3519)</b>						
$V_{IL}$	$\overline{MR}$ Input Threshold		$0.3 \times V_{CC}$			V
$V_{IH}$	$\overline{MR}$ Input Threshold				$0.7 \times V_{CC}$	
	$\overline{MR}$ Input Pulse Width		1			$\mu s$
	$\overline{MR}$ Glitch Rejection			100		ns
	$\overline{MR}$ Internal Pull-Up Resistance	$T_A = 25^\circ C$	35	52	75	k $\Omega$
	$\overline{MR}$ to Reset Delay	$V_{CC} = 5V$			230	ns

1. Over-temperature limits are guaranteed by design, not production tested.

2. Watchdog timeout period C is not available on AAT3513, AAT3514, and AAT3518.

3. WDI is internally serviced within the watchdog period if WDI is left unconnected.

4. The WDI input current is specified as the average input current when the WDI input is driven high or low. The WDI input is designed for a three-stated-output device with a  $10\mu A$  maximum leakage current and capable of driving a maximum capacitive load of 200pF. The three-state device must be able to source and sink at least  $200\mu A$  when active.

### Typical Characteristics

Unless otherwise noted,  $V_{IN} = 3V$ ,  $T_A = 25^\circ C$ .

Supply Current vs. Temperature

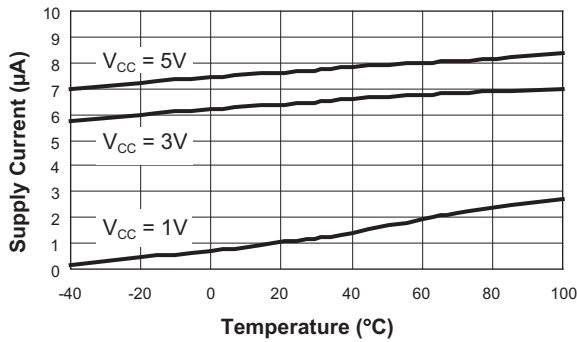

$V_{CC}$  Falling to RESET Propagation Delay vs. Temperature

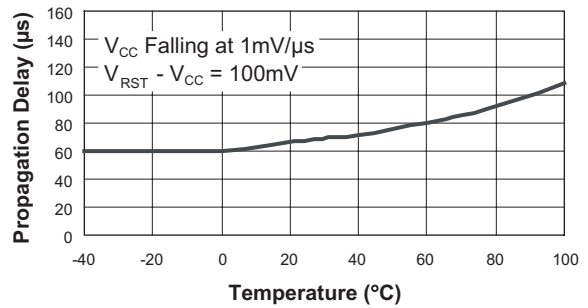

Manual Reset to RESET Propagation Delay vs. Temperature

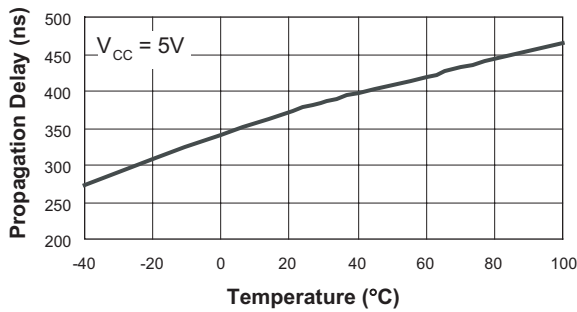

Normalized Reset Timeout Period vs. Temperature

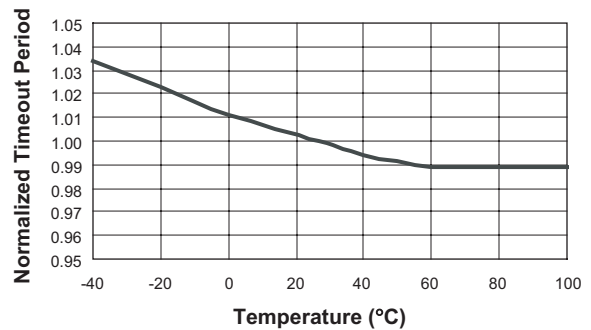

Normalized Watchdog Timeout Period vs. Temperature

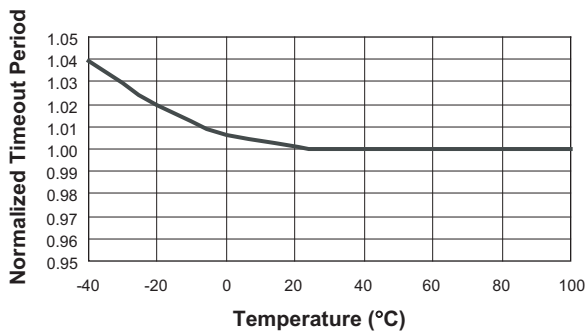

Maximum  $V_{CC}$  Transient Duration vs. Reset Threshold Overdrive

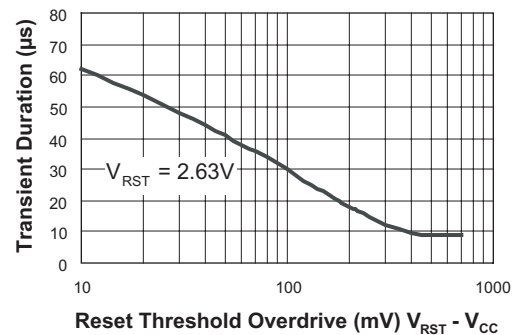

### Typical Characteristics

Unless otherwise noted,  $V_{IN} = 3V$ ,  $T_A = 25^\circ C$ .

#### Bidirectional Pullup Characteristic

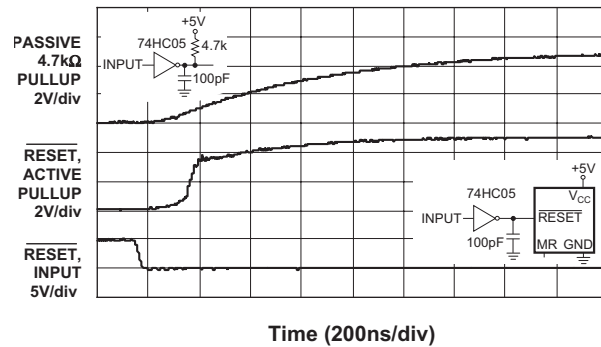

### Functional Block Diagram

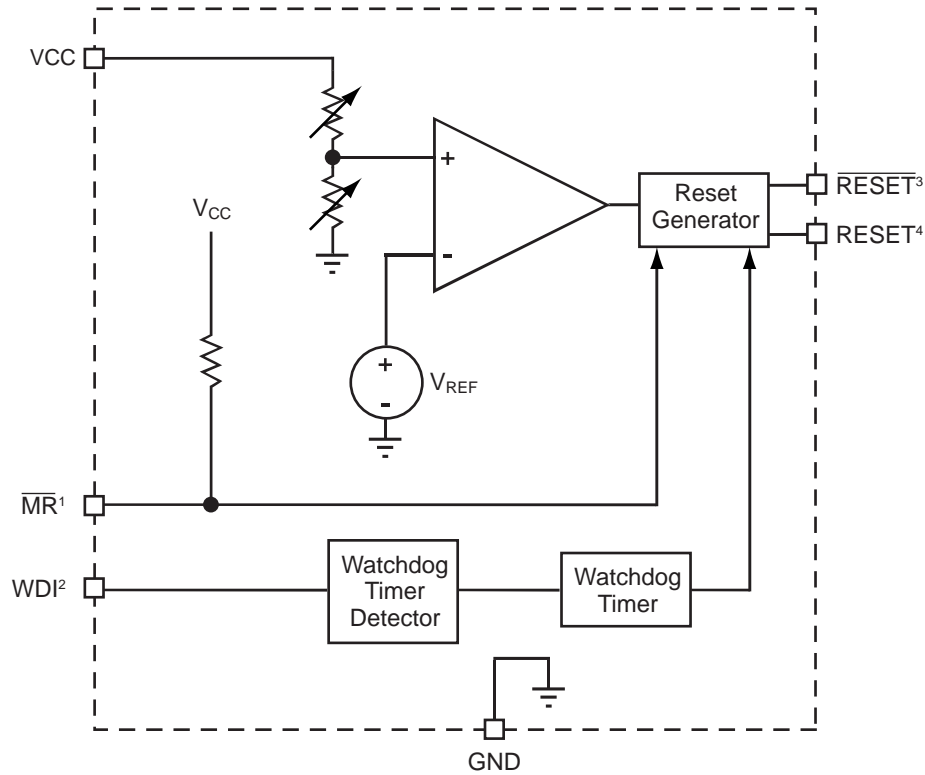

1. MR pin available on AAT3510/1/2/5/6/7/9.
2. WDI pin available on AAT3510/1/2/3/4/7/8.
3. RESET pin available on AAT3510/1/3/4/5/6/7/8/9.
4. RESET pin available on AAT3512/3/4/5/6/8/9.



### Factory-Trimmed Reset Thresholds<sup>1</sup> and Ordering Information

AAT351x IGV - X.XX - X - X - T1

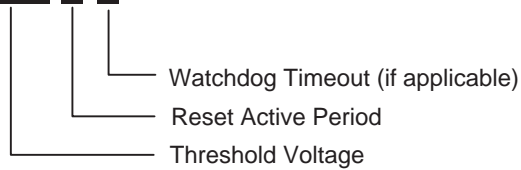

#### Reset Active Period

- A:  $T_{R(MIN)} = 1\text{ms}$
- B:  $T_{R(MIN)} = 20\text{ms}$
- C:  $T_{R(MIN)} = 140\text{ms}$

#### Watchdog Timeout Period

- A:  $T_{WD(NOM)} = 6.3\text{ms}$
- B:  $T_{WD(NOM)} = 102\text{ms}$
- C:  $T_{WD(NOM)} = 1600\text{ms}^1$

#### VDD Threshold Voltage

2.63: $V_{TH(NOM)} = 2.63\text{V}$	3.90: $V_{TH(NOM)} = 3.9\text{V}$
2.70: $V_{TH(NOM)} = 2.7\text{V}$	4.00: $V_{TH(NOM)} = 4.0\text{V}$
2.80: $V_{TH(NOM)} = 2.8\text{V}$	4.10: $V_{TH(NOM)} = 4.1\text{V}$
2.93: $V_{TH(NOM)} = 2.93\text{V}$	4.20: $V_{TH(NOM)} = 4.2\text{V}$
3.00: $V_{TH(NOM)} = 3.0\text{V}$	4.38: $V_{TH(NOM)} = 4.3\text{V}$
3.08: $V_{TH(NOM)} = 3.08\text{V}$	4.40: $V_{TH(NOM)} = 4.38\text{V}$
3.20: $V_{TH(NOM)} = 3.2\text{V}$	4.50: $V_{TH(NOM)} = 4.5\text{V}$
3.30: $V_{TH(NOM)} = 3.3\text{V}$	4.63: $V_{TH(NOM)} = 4.63\text{V}$
3.40: $V_{TH(NOM)} = 3.4\text{V}$	4.70: $V_{TH(NOM)} = 4.7\text{V}$
3.50: $V_{TH(NOM)} = 3.5\text{V}$	4.80: $V_{TH(NOM)} = 4.8\text{V}$
3.60: $V_{TH(NOM)} = 3.6\text{V}$	4.90: $V_{TH(NOM)} = 4.9\text{V}$
3.70: $V_{TH(NOM)} = 3.7\text{V}$	5.00: $V_{TH(NOM)} = 5.0\text{V}$
3.80: $V_{TH(NOM)} = 3.8\text{V}$	

1. Watchdog timeout period C is not available on AAT3513, AAT3514, and AAT3518.

### Ordering Information

Package	Marking <sup>1</sup>	Part Number (Tape and Reel) <sup>2</sup>
SOT23-5	HVXYY	<b>AAT3510IGV-2.63-C-C-T1</b>
SOT23-5	HUXYY	<b>AAT3510IGV-2.93-C-C-T1</b>
SOT23-5	HGXYY	<b>AAT3510IGV-3.08-C-C-T1</b>
SOT23-5	HHXYY	<b>AAT3510IGV-4.38-C-C-T1</b>
SOT23-5	EWXYY	<b>AAT3511IGV-2.63-C-C-T1</b>
SOT23-5	MYXYY	<b>AAT3512IGV-2.63-A-C-T1</b>
SOT23-5		AAT3512IGV-2.63-C-C-T1
SOT23-5	HEXYY	<b>AAT3515IGV-2.63-C-T1</b>
SOT23-5	HIXYY	<b>AAT3515IGV-2.93-B-T1</b>
SOT23-5	KLXYY	<b>AAT3515IGV-2.93-C-T1</b>
SOT23-5	JNXYY	<b>AAT3515IGV-3.08-C-T1</b>
SOT23-5	KMXYY	<b>AAT3515IGV-4.38-C-T1</b>
SOT23-5	MFXY	<b>AAT3515IGV-4.63-C-T1</b>
SOT23-5	INXYY	<b>AAT3517IGV-2.63-C-C-T1</b>
SOT23-5	LZXYY	<b>AAT3517IGV-2.8-B-C-T1</b>
SOT23-5	IQXYY	<b>AAT3517IGV-2.93-C-C-T1</b>



All AnalogicTech products are offered in Pb-free packaging. The term “Pb-free” means semiconductor products that are in compliance with current RoHS standards, including the requirement that lead not exceed 0.1% by weight in homogeneous materials. For more information, please visit our website at <http://www.analogictech.com/pbfree>.

1. XYY = date and assembly code.

2. Sample stock is generally held on part numbers listed in **BOLD**.

### Package Information

#### SOT23-5

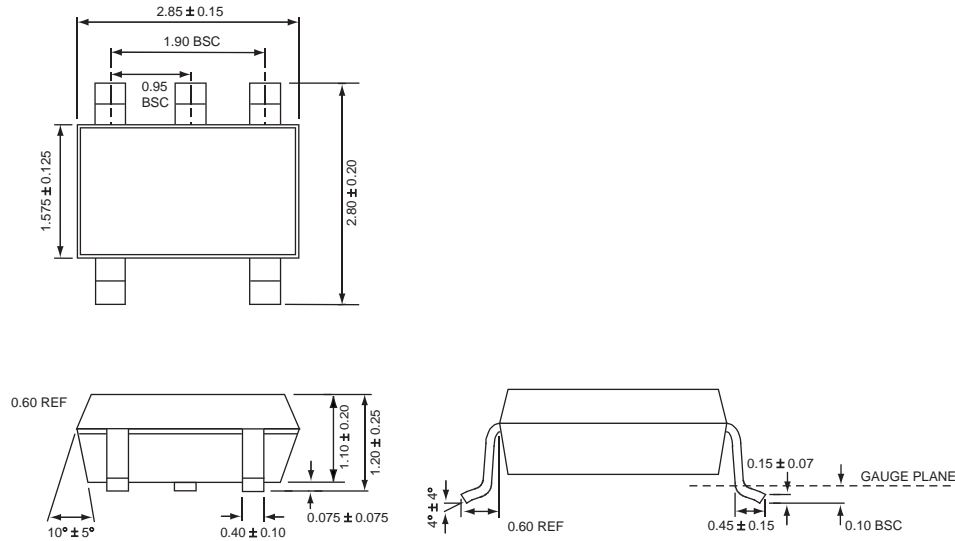

All dimensions in millimeters.

© Advanced Analogic Technologies, Inc.

AnalogicTech cannot assume responsibility for use of any circuitry other than circuitry entirely embodied in an AnalogicTech product. No circuit patent licenses, copyrights, mask work rights, or other intellectual property rights are implied. AnalogicTech reserves the right to make changes to their products or specifications or to discontinue any product or service without notice. Customers are advised to obtain the latest version of relevant information to verify, before placing orders, that information being relied on is current and complete. All products are sold subject to the terms and conditions of sale supplied at the time of order acknowledgement, including those pertaining to warranty, patent infringement, and limitation of liability. AnalogicTech warrants performance of its semiconductor products to the specifications applicable at the time of sale in accordance with AnalogicTech's standard warranty. Testing and other quality control techniques are utilized to the extent AnalogicTech deems necessary to support this warranty. Specific testing of all parameters of each device is not necessarily performed.

**Advanced Analogic Technologies, Inc.**  
 830 E. Arques Avenue, Sunnyvale, CA 94085  
 Phone (408) 737-4600  
 Fax (408) 737-4611